

Top View

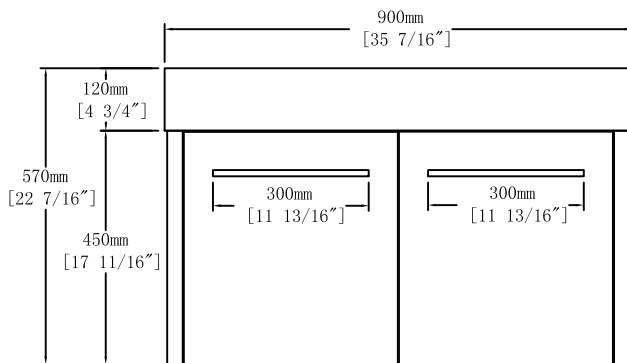

Front View

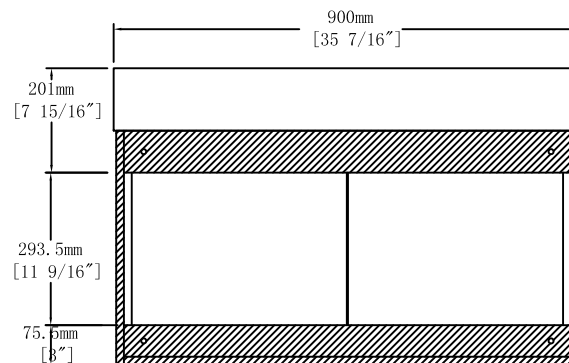
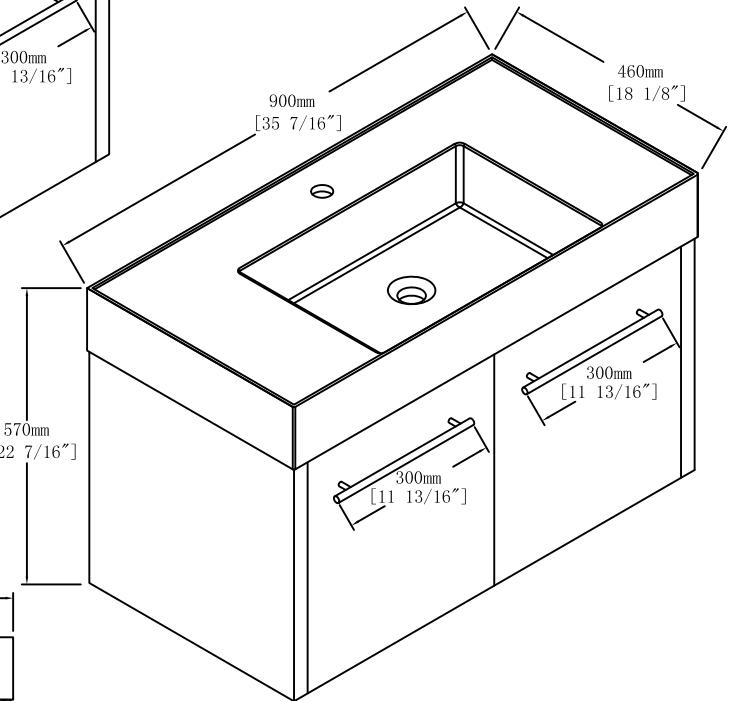
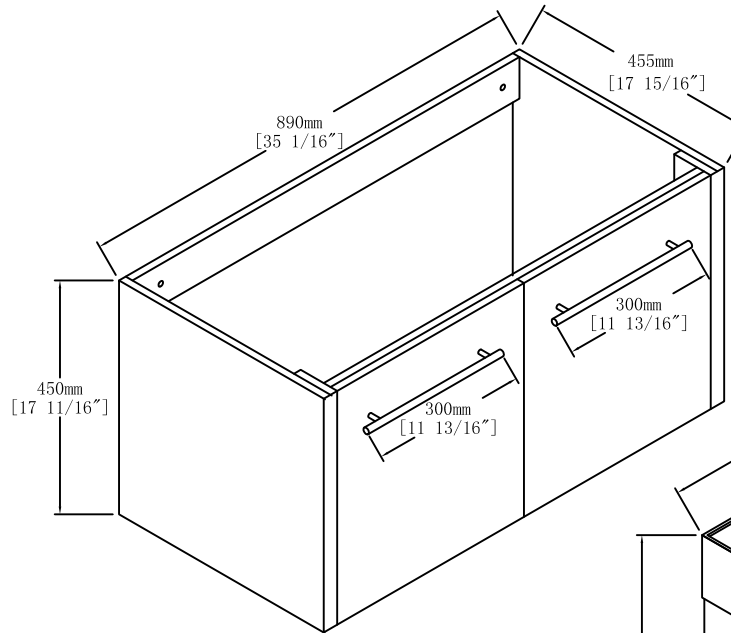

Back View



Item NO.

BV B09136

Version

V1

Project

Date

2024-3-31